

КОМПРЕССИОННЫЕ ФИТИНГИ
COMPRESSION FITTINGS



MASTER <

Тип коробки
Box type

Размеры
Dimensions

B	60x30x40 cm
C	40x30x30 cm

> КОМПРЕССИОННЫЕ ФИТИНГИ - ОБЩИЕ ХАРАКТЕРИСТИКИ

ОПИСАНИЕ ТОВАРА

Компрессионные фитинги из ПП Асторе - соединения, используемые при сборке полиэтиленовых трубопроводов водоснабжения. Их основными сферами применения являются питьевое и очищаемое водоснабжение и ирригация.

АССОРТИМЕНТ

Широкий ассортимент фитингов Асторе позволяет удовлетворить самые строгие запросы по монтажу трубопроводов. Номенклатура диаметров от 16 мм до 110 мм. Резьбовые соединения, начиная с R 1 1/4", комплектуются уплотняющим металлическим кольцом на наружной резьбе.

МАТЕРИАЛЫ

Корпус и гайка: черный ПП сополимер
Зацепляющая втулка: белая ацеталевая смола
Тороидальное уплотнение: НБР (нитрил-бутил-резина)
Кольцо жесткости: нержавеющая сталь AISI 430
Металлические фланцы: (изделие 520): Fe 360, оцинкованный

НОРМЫ И СТАНДАРТЫ

Компрессионные фитинги Асторе произведены в соответствии с требованиями норм ISO 3458, ISO 3459, ISO 3501, ISO 3503, ISO 14236, DIN 8076-3, UNI 9561. Фитинги могут быть установлены на ПЭ трубах, соответствующих требованиям норм ISO 4427, DIN 8072, DIN 8074, UNI EN 12201. Резьбовые фитинги производятся согласно нормам ISO 7-1.

РАБОЧЕЕ ДАВЛЕНИЕ

При 20°C и диаметре от 16 мм до 63 мм - 16 бар, от 75 мм до 110 мм - 10 бар.
Компания Асторе работает по системе качества ISO 9001 (сертификат №354).
Компрессионные фитинги Асторе прошли проверку DVGW (Немецкий Союз газо- и водоснабжения) и получили допуск на их использование (Сертификат N°DW-8616BQ0078).
Компания Асторе работает по системе качества ISO 14001 (сертификат №129).

> COMPRESSION FITTINGS - GENERAL CHARACTERISTICS

DESCRIPTION

Astore PP compression fittings are joints for PE pipes dedicated to water adduction systems.
They can be used both in irrigation field and drinking water systems.

RANGE

Astore joints range includes a large number of items apt to satisfy a very wide range of plant engineering installation requirements.
The joints range leaves from D 16 mm up to D 110 mm. The joints provided with threads have a metal reinforcement on the external part of the thread, leaving from R 1 1/4".

MATERIALS

Body and nut in polypropylene black co-polymer, clinching ring in white POM resin, O-ring in NBR, reinforcement ring in AISI 430.

REFERENCE STANDARDS

Astore compression fitting is manufactured in compliance with the requirements of standards ISO DIN 17885, ISO 14236, DIN 8076-3, UNI 9561.
The joints can be installed on PE pipes which are in compliance with standards ISO 4427, DIN 8072, DIN 8074, UNI EN 12201. The threaded versions are manufactured in compliance with standard ISO 7-1.

PRESSURE RATING AT 20° C

16 bar from D 16 mm up to D 63 mm, 10 bar from D 75 mm up to D 110 mm.
Astore is an ISO 9001 certified company, certificate n° 354.
Astore compression fittings are approved by DVGW (DW-8616BQ0078).
Astore is on ISO 14001 certified company N° 129.

> D 16÷63

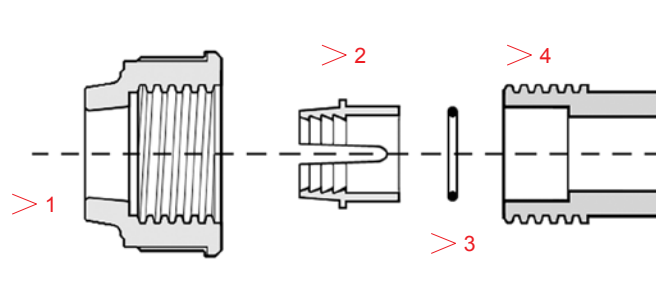

ОПИСАНИЕ КОМПОНЕНТОВ

- 1) Гайка
- 2) Зацепляющая втулка
- 3) Торoidalное уплотнение
- 4) Корпус

COMPONENTS DESCRIPTION

- 1) Nut
- 2) Clinching ring
- 3) O-ring
- 4) Body

> D 75÷110

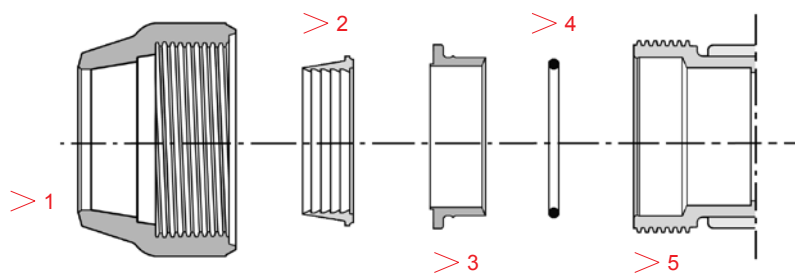

ОПИСАНИЕ КОМПОНЕНТОВ

- 1) Гайка
- 2) Зацепляющая втулка
- 3) Упорное кольцо
- 4) Уплотнение
- 5) Корпус

COMPONENTS DESCRIPTION

- 1) Nut
- 2) Clinching ring
- 3) Thrust bushing
- 4) O-ring
- 5) Body

> СЕРТИФИКАТЫ СООТВЕТСТВИЯ

Итальянский Институт Пластмасс (IIP) официально признали соответствие системы качества фирмы "A.V.F. Astore Valves and Fittings srl" нормам UNI EN ISO 9001 относительно литьевого формования фитингов и деталей клапанов из термопластичных материалов, а также относительно сборки клапанов.

В 2008 году Асторе получил сертификат ISO 14001 для своей Системы Экологического Менеджмента. Согласно нормам ISO 14001:2004, предприятия обязаны делать всё, что в их силах для того, чтобы довести до минимума вред окружающей среде.

Это влечет за собой улучшение производственного процесса с повышением эффективности деятельности предприятия, снижением энергетических расходов и оптимизацией управления отходов.

Сертификат ISO 14001:2004 является очередным шагом вперед к повышению стандарта качества компании Асторе.

SISTEMA DI GESTIONE
UNI EN ISO 9001 CERT. IIP N° 354
UNI EN ISO 14001 CERT. IIP N° 129



> COMPANY APPROVAL

Italian Institute of Plastics (IIP) has attested the conformity of Astore production system to the standard UNI EN ISO 9001. Astore has obtained the certification according to UNI EN ISO 14001 of his own Environmental Management System. This implies an improvement of the production process with an efficiency increase, the substantial reduction of the energetic consumption and the waste management. Compression fittings, as all other products Astore, are "made in Italy". The above is attested by the certifying authority NSF with the Quality Registration Mark "Origin and Quality Controlled" (OQC) cert. nr 7.

> 510

СОЕДИНИТЕЛЬНАЯ МУФТА COUPLING

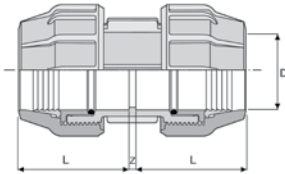

DxD	L	Z	g - гр.	Ref. - Код	Pack	Box	Master
16x16	45	4	42	GG.510.160.00	20	360	B
20x20	50	4	66	GG.510.200.00	20	220	B
25x25	57	4	96	GG.510.250.00	10	150	B
32x32	64	4	144	GG.510.320.00	10	100	B
40x40	76	4	242	GG.510.400.00	5	50	B
50x50	88	4	374	GG.510.500.00	5	35	B
63x63	103	9	599	GG.510.630.00	5	20	B
75x75	118	4	905	GR.510.750.00	1	15	B
90x90	136	5	1290	GR.510.900.00	1	11	B
110x110	151	4	1970	GR.510.110.00	1	6	B

> 511

МУФТА С НАРУЖНОЙ РЕЗЬБОЙ MALE ADAPTOR

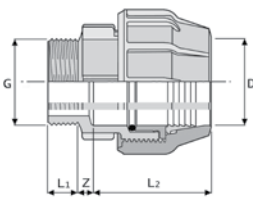

DxG	L1	L2	Z	g - гр.	Ref. - Код	Pack	Box	Master
16x3/8"	18	45	16	23	GG.511.16A.00	20	500	B
16x1/2"	18	45	20	23	GG.511.16B.00	20	500	B
16x3/4"	20	45	20	25	GG.511.16C.00	20	500	B
20x1/2"	18	50	18	36	GG.511.20B.00	20	400	B
20x3/4"	20	50	19	38	GG.511.20C.00	20	400	B
25x1/2"	18	57	19	53	GG.511.25B.00	10	250	B
25x3/4"	20	57	20	54	GG.511.25C.00	10	250	B
25x1"	20	57	26	56	GG.511.25D.00	10	250	B
32x3/4"	20	64	23	81	GG.511.32C.00	10	150	B
32x1"	20	64	26	83	GG.511.32D.00	10	150	B
32x1 1/4"	24	64	26	89	GG.511.32E.00	10	150	B
40x1"	20	76	26	137	GG.511.40D.00	5	90	B
40x1 1/4"	24	76	29	140	GG.511.40E.00	5	90	B
40x1 1/2"	24	76	29	143	GG.511.40F.00	5	90	B
50x1 1/4"	24	88	29	214	GG.511.50E.00	5	55	B
50x1 1/2"	24	88	29	214	GG.511.50F.00	5	55	B
50x2"	29	88	34	222	GG.511.50G.00	5	55	B
63x1 1/2"	24	103	29	341	GG.511.63F.00	5	30	B
63x2"	29	103	34	347	GG.511.63G.00	5	30	B
63x2 1/2"	32	103	39	361	GG.511.63H.00	5	30	B
75x2"	29	118	34	520	GR.511.75G.00	1	25	B
75x2 1/2"	32	118	40	516	GR.511.75H.00	1	25	B
75x3"	38	118	43	534	GR.511.75I.00	1	25	B
90x2"	29	136	34	740	GR.511.90G.00	1	16	B
90x2 1/2"	32	136	40	750	GR.511.90H.00	1	16	B
90x3"	38	136	43	750	GR.511.90I.00	1	16	B
90x4"	44	136	49	793	GR.511.90L.00	1	16	B
110x2"	27	150	34	1040	GG.511.11G.00	1	8	B
110x3"	38	151	43	1138	GR.511.11I.00	1	8	B
110x4"	44	151	49	1156	GR.511.11L.00	1	8	B

512 <

ПЕРЕХОДНАЯ МУФТА REDUCER COUPLING

DxD1	L1	L2	Z	g - гр.	Ref. - Код	Pack	Box	Master
20x16	40,5	50	4	54	GG.512.20A.00	20	260	B
25x20	50	57	4	81	GG.512.25B.00	10	180	B
32x20	50	57,5	4	109	GG.512.32B.00	10	110	B
32x25	53	58	4	123	GG.512.32C.00	10	110	B
40x25	57	76	4	183	GG.512.40C.00	5	70	B
40x32	64	76	4	190	GG.512.40D.00	5	70	B
50x25	57	88	4	262	GG.512.50C.00	5	40	B
50x32	64	88	4	281	GG.512.50D.00	5	40	B
50x40	76	88	4	319	GG.512.50E.00	5	40	B
63x32	64	103	4	403	GG.512.63D.00	5	25	B
63x40	76	103	4	450	GG.512.63E.00	5	25	B
63x50	88	103	4	492	GG.512.63F.00	5	20	B
75x50	88	118	4	664	GR.512.75F.00	1	15	B
75x63	103	118	4	757	GR.512.75G.00	1	15	B
90x63	103	136	4	980	GR.512.90G.00	1	12	B
90x75	118	136	4	1123	GR.512.90H.00	1	12	B
110x75	118	151	4	1502	GG.512.11H.00	1	6	B
110x90	136	151	4	1682	GR.512.11I.00	1	6	B

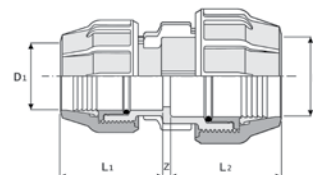

525 <

ADAPTOR WITH NUT ADATTATORE A GHIERA

DxG	L	L1	Z	g - гр.	Ref. - Код	Pack	Box	Master
25x1"	55	13,2	30	70	GG.525.25D.00	10	200	B
32x1"	57	13,2	33	105	GG.525.32D.00	10	140	B

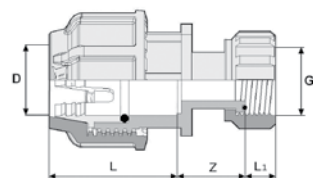

> 601

МУФТА С ВНУТРЕННЕЙ РЕЗЬБОЙ FEMALE ADAPTOR

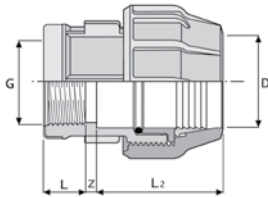

DxG	L	L2	Z	g - гр.	Ref. - Код	Pack	Box	Master
16x3/8"	19	45	4	26	GG.601.16A.00	20	500	B
16x1/2"	19	45	4	30	GG.601.16B.00	20	500	B
20x1/2"	19	50	5	41	GG.601.20B.00	20	400	B
20x3/4"	21	50	6	47	GG.601.20C.00	20	340	B
25x1/2"	19	57	3	54	GG.601.25B.00	10	250	B
25x3/4"	21	57	6	61	GG.601.25C.00	10	250	B
25x1"	21	57	8	68	GG.601.25D.00	10	200	B
32x1/2"	19	64	4	85	GG.601.32B.00	10	150	B
32x3/4"	21	64	4	88	GG.601.32C.00	10	150	B
32x1"	21	64	7	95	GG.601.32D.00	10	150	B
32x1 1/4"	25	64	8	100	GG.601.32E.00	10	130	B
40x1"	21	76	4	148	GG.601.40D.00	5	90	B
40x1 1/4"	25	76	4	155	GG.601.40E.00	5	90	B
40x1 1/2"	25	76	6	172	GG.601.40F.00	5	90	B
50x1 1/4"	25	88	4	231	GG.601.50E.00	5	55	B
50x1 1/2"	25	88	6	234	GG.601.50F.00	5	55	B
50x2"	30	88	6	254	GG.601.50G.00	5	55	B
63x1 1/2"	25	103	9	360	GG.601.63F.00	5	30	B
63x2"	30	103	3	374	GG.601.63G.00	5	30	B
75x2"	30	118	7	537	GR.601.75G.00	1	25	B
75x2 1/2"	33	118	4	635	GR.601.75H.00	1	25	B
75x3"	39	118	6	580	GR.601.75I.00	1	25	B
90x2"	30	136	3	700	GR.601.90G.00	1	16	B
90x2 1/2"	33	136	10	730	GR.601.90H.00	1	16	B
90x3"	39	136	10	932	GR.601.90I.00	1	16	B
110x3"	39	151	10	1316	GG.601.11I.00	1	8	B
110x4"	45	151	10	1390	GR.601.11L.00	1	8	B

> 521

ЗАГЛУШКА PLUG

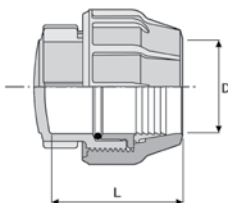

D	L	g - гр.	Ref. - Код	Pack	Box	Master
16	45	29	GG.521.160.00	20	500	B
20	50	40	GG.521.200.00	20	400	B
25	57	55	GG.521.250.00	10	250	B
32	64	86	GG.521.320.00	10	150	B
40	76	152	GG.521.400.00	5	90	B
50	88	230	GG.521.500.00	5	60	B
63	103	348	GG.521.630.00	5	30	B
75	118	452	GR.521.750.00	1	28	B
90	136	750	GR.521.900.00	1	22	B
110	151	1031	GR.521.110.00	1	8	B

513 <

ОТВОД ELBOW

DxD	L	Z	g - гр.	Ref. - Код	Pack	Box	Master
16x16	45	11	45	GG.513.160.00	20	360	B
20x20	50	13	70	GG.513.200.00	20	200	B
25x25	57	15	105	GG.513.250.00	10	150	B
32x32	64	19	161	GG.513.320.00	10	80	B
40x40	76	23	269	GG.513.400.00	5	50	B
50x50	88	28	415	GG.513.500.00	5	30	B
63x63	103	35	656	GG.513.630.00	5	15	B
75x75	118	41	994	GR.513.750.00	1	11	B
90x90	136	49	1450	GR.513.900.00	1	8	B
110x110	151	60	2193	GR.513.110.00	1	4	B

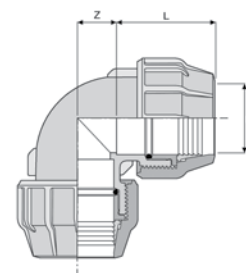

519 <

ОТВОД С НАРУЖНОЙ РЕЗЬБОЙ ELBOW MALE THREADED

DxG	L1	L2	Z	Z1	g - гр.	Ref. - Код	Pack	Box	Master
16x1/2"	45	18	11	40	29	GG.519.16B.00	20	400	B
20x1/2"	50	18	13	46	50	GG.519.20B.00	20	260	B
20x3/4"	50	20	13	46	50	GG.519.20C.00	20	260	B
25x1/2"	57	20	15	52	75	GG.519.25B.00	10	180	B
25x3/4"	57	20	15	52	75	GG.519.25C.00	10	180	B
25x1"	57	20	15	52	75	GG.519.25D.00	10	180	B
32x1"	64	20	19	61	120	GG.519.32D.00	10	110	B
32x1 1/4"	64	24	19	61	120	GG.519.32E.00	10	110	B
40x1 1/4"	76	24	23	69	198	GG.519.40E.00	5	60	B
40x1 1/2"	76	24	23	69	198	GG.519.40F.00	5	60	B
50x1 1/2"	88	24	28	82	305	GG.519.50F.00	5	35	B
50x2"	88	29	28	82	305	GG.519.50G.00	5	35	B
63x2"	103	29	35	96	480	GG.519.63G.00	5	20	B
63x2 1/2"	103	32	35	96	480	GG.519.63H.00	5	20	B
75x2 1/2"	118	32	41	111	709	GR.519.75H.00	1	14	B
75x3"	118	38	41	111	709	GR.519.75I.00	1	14	B
90x3"	136	38	49	128	1031	GR.519.90I.00	1	10	B
110x4"	153	44	58	143	1549	GR.519.11L.00	1	5	B

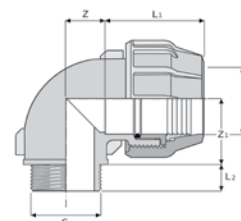

> 518

ОТВОД С ВНУТРЕННЕЙ РЕЗЬБОЙ ELBOW FEMALE THREADED

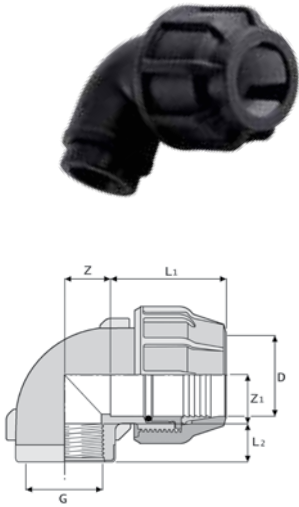

DxG	L1	L2	Z	Z1	g - гр.	Ref. - Код	Pack	Box	Master
16x3/8"	45	19	11	25	32	GG.518.16A.00	20	400	B
16x1/2"	45	19	11	28	32	GG.518.16B.00	20	400	B
20x1/2"	50	19	13	28	51	GG.518.20B.00	20	260	B
20x3/4"	57	20	13	28	51	GG.518.20C.00	20	260	B
25x1/2"	57	19	13	28	75	GG.518.25B.00	10	180	B
25x3/4"	57	21	15	31	77	GG.518.25C.00	10	180	B
25x1"	57	21	15	31	77	GG.518.25D.00	10	160	B
32x1/2"	64	19	19	40	122	GG.518.32B.00	10	110	B
32x3/4"	64	21	19	40	122	GG.518.32C.00	10	110	B
32x1"	64	21	19	40	122	GG.518.32D.00	10	110	B
32x1 1/4"	64	25	19	40	122	GG.518.32E.00	10	90	B
40x1 1/4"	76	25	23	44	198	GG.518.40E.00	5	60	B
40x1 1/2"	76	25	23	51	198	GG.518.40F.00	5	60	B
50x1 1/2"	88	25	28	55	316	GG.518.50F.00	5	35	B
50x2"	88	30	28	55	316	GG.518.50G.00	5	35	B
63x2"	103	30	35	63	582	GG.518.63G.00	5	20	B
63x2 1/2"	103	33	35	78	499	GG.518.63H.00	5	20	B
75x2 1/2"	118	33	41	73	810	GR.518.75H.00	1	14	B
75x3"	118	39	41	73	810	GR.518.75I.00	1	14	B
90x3"	136	39	49	87	1213	GR.518.90I.00	1	10	B
110x4"	151	45	60	103	1767	GR.518.11L.00	1	5	B

> 514

ТРОЙНИК TEE

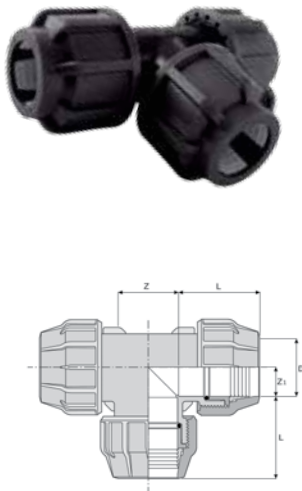

DxDxD	L	Z	Z1	g - гр.	Ref. - Код	Pack	Box	Master
16x16x16	45	22	11	66	GG.514.160.00	20	220	B
20x20x20	50	26	13	101	GG.514.200.00	20	120	B
20x25x20	53	26	13	115	GG.514.20C.00	10	120	B
25x25x25	57	30	15	151	GG.514.250.00	10	90	B
25x32x25	54	30	15	190	GG.514.25D.00	10	90	B
32x32x32	64	38	19	236	GG.514.320.00	10	50	B
40x40x40	76	46	23	390	GG.514.400.00	5	30	B
50x50x50	88	56	28	598	GG.514.500.00	5	20	B
63x63x63	103	70	35	944	GG.514.630.00	4	12	B
75x75x75	118	82	41	1427	GR.514.750.00	1	7	B
90x90x90	136	98	49	2113	GR.514.900.00	1	5	B
110x110x110	151	120	60	3191	GR.514.110.00	1	3	B

516 <

ТРОЙНИК С НАРУЖНОЙ РЕЗЬБОЙ TEE MALE THREADED

DxGxD	L1	L2	Z	Z1	g - гр.	Ref. - Код	Pack	Box	Master
16x1/2"x16	45	18	22	40	52	GG.516.16B.00	20	240	B
20x1/2"x20	50	18	26	46	82	GG.516.20B.00	20	140	B
20x3/4"x20	50	20	26	46	82	GG.516.20C.00	20	140	B
25x3/4"x25	57	20	30	52	122	GG.516.25C.00	10	100	B
25x1"x25	57	20	30	52	122	GG.516.25D.00	10	100	B
32x1"x32	64	20	38	61	190	GG.516.32D.00	10	60	B
32x1 1/4"x32	64	24	38	61	190	GG.516.32E.00	10	60	B
40x1 1/4"x40	76	24	46	69	322	GG.516.40E.00	5	30	B
40x1 1/2"x40	76	24	46	69	322	GG.516.40F.00	5	30	B
50x1 1/2"x50	88	24	56	82	490	GG.516.50F.00	5	20	B
50x2"x50	88	29	56	82	490	GG.516.50G.00	5	20	B
63x2"x63	103	29	70	96	775	GG.516.63G.00	4	12	B
63x2 1/2"x63	103	32	70	96	775	GG.516.63H.00	4	12	B
75x2 1/2"x75	118	32	82	111	790	GR.516.75H.00	1	10	B
90x3"x90	125	38	97	122	1800	GR.516.90I.00	1	6	B
110x4"x110	144	44	119	143	2523	GR.516.11L.00	1	3	B

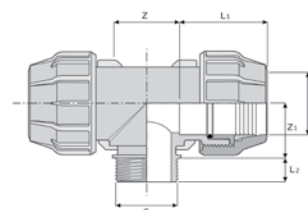

515 <

ТРОЙНИК С ВНУТРЕННЕЙ РЕЗЬБОЙ TEE FEMALE THREADED

DxG	L1	L2	Z	Z1	g - гр.	Ref. - Код	Pack	Box	Master
16x3/8"x16	45	19	22	25	55	GG.515.16A.00	20	240	B
16x1/2"x16	45	19	22	19	48	GG.515.16B.00	20	240	B
20x1/2"x20	50	19	26	27	85	GG.515.20B.00	20	140	B
20x3/4"x20	50	19	26	27	85	GG.515.20C.00	20	140	B
25x1/2"x25	57	19	30	31	127	GG.515.25B.00	10	100	B
25x3/4"x25	57	21	30	31	127	GG.515.25C.00	10	100	B
25x1"x25	57	21	30	35	127	GG.515.25D.00	10	100	B
32x1/2"x32	64	19	38	40	195	GG.515.32B.00	10	60	B
32x3/4"x32	64	21	38	40	195	GG.515.32C.00	10	60	B
32x1"x32	64	21	38	40	195	GG.515.32D.00	10	60	B
32x1 1/4"x32	64	25	38	40	195	GG.515.32E.00	10	50	B
40x1"x40	76	21	46	44	322	GG.515.40D.00	5	30	B
40x1 1/4"x40	76	25	46	44	322	GG.515.40E.00	5	30	B
40x1 1/2"x40	76	25	46	50	322	GG.515.40F.00	5	30	B
50x1 1/2"x50	88	25	56	55	510	GG.515.50F.00	5	20	B
50x2"x50	88	25	56	55	510	GG.515.50G.00	5	20	B
63x2"x63	103	30	70	64	801	GG.515.63G.00	4	12	B
63x2 1/2"x63	103	33	70	64	801	GG.515.63H.00	4	12	B
75x2 1/2"x75	118	33	82	75	1270	GR.515.75H.00	1	10	B
90x3"x90	136	36	98	87	1882	GR.515.90I.00	1	6	B
110x4"x110	151	40	120	103	2780	GR.515.11L.00	1	3	B

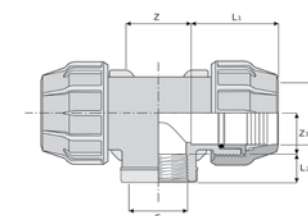

> 520

ФЛАНЦЕВОЕ СОЕДИНЕНИЕ FLANGE ADAPTOR

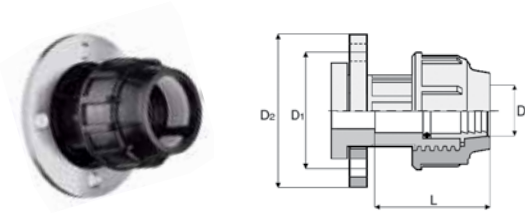

DxDN	L	D1	D2	н° дрель n° Drill	g - гр.	Ref. - Код	Pack	Box	Master
75x2 1/2"	118	145	185	4	886	GR.520.75H.00	1	5	C
75x3"	118	160	200	8	1339	GR.520.75I.00	1	5	C
90x3"	136	160	200	4	1198	GR.520.90I.00	1	8	B
90x4"	136	180	220	8	1395	GR.520.90L.00	1	8	B
110x4"	151	180	220	8	1684	GR.520.11L.00	1	6	B

> 523

ТРОЙНИК ПЕРЕХОДНОЙ REDUCING TEE



DxD1xD	L	L1	Z	Z1	g - гр.	Ref. - Код	Box	Master
25x20x25	51,5	47	30	14	132	GG.523.25B.00	100	B
32x25x32	57,5	51	32	19	207	GG.523.32C.00	60	B
40x32x40	83	75	40	17	340	GG.523.40D.00	40	B
50x40x50	100	90	44	23	580	GG.523.50E.00	20	B
63x50x63	95	85	66	33	950	GG.523.63F.00	12	B

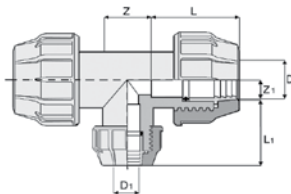

524 <

НАСТЕННАЯ СКОБА WALLBRACKETS

DxG	L	L1	L2	Z	A	B	g - гр.	Ref. - Код	Pack	Box	Master
25x3/4"	83,5	57	21	14	6	62	76	GG.524.25C.00	10	150	B

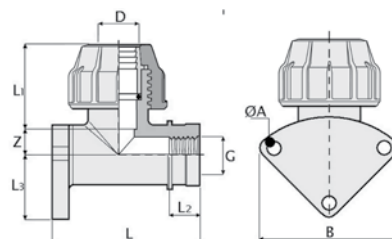

CHS <

КЛЮЧ TIGHTENING KEY

D	Ref. - Код	g - гр.
40÷63	60.CAS.40G.00	400
75÷110	60.CAS.75L.00	1000

